

# Acoustic Levitation on an Annular Plate

Mehmet Hakan Kandemir

Department of Mechanical Engineering, Middle East Technical University, Ankara, Turkey.

Mehmet Çalışkan

Department of Mechanical Engineering, Middle East Technical University, Ankara, Turkey.

## Summary

In standing wave acoustic levitation technique, a standing wave is obtained between a source and a reflector. The nodes of the standing wave act as a linear spring to attract the particles towards the pressure nodes, thus particles can be suspended in air. This operation can be performed on continuous structures as well as in several number of axes. In this study an annular acoustic levitation setup is designed. The setup consists of two Langevin type piezoelectric transducers, two waveguides, an annular plate, an annular concave reflector, supporting structures, a signal generator and a power amplifier. The transducers are activated by harmonic signals generated by a signal generator and amplified by an amplifier to excite the waveguides. The waveguides amplify the vibration amplitude and in turn, excite the annular plate to a bending mode at a certain frequency. As the plate vibrates in bending mode, it excites the air and generates sound waves. Several types of bending modes of the plate are simulated and evaluated. With the right positioning of the reflector plate, standing waves are formed between the annular vibrating plate and the reflector plate. At the pressure nodes of the standing wave, it is demonstrated that small particles can be suspended in air.

PACS no. 43.25.Uv, 43.25.Ts

## 1. Introduction

The definition of acoustic levitation is levitation of matter using sound waves. Unlike any other levitation technique, it has almost no restrictions on the state and material of levitated matter. It was first observed by a German researcher, Kundt [1] in an impedance tube experiment. When a standing wave is obtained in the impedance tube, small dust particles are observed to concentrate at the nodes of the standing wave pattern. A standing wave acoustic levitation setup consists of a sound source and a reflector parallel to it. Adjusting the distance between the source and the reflector, standing wave is obtained. Whymark (1975) realized a setup of a source and a flat reflector on a single axis [2]. In 1992, a setup tracking the changes in the air and adjusting the position of the reflector is developed by Zhuyou et al. [3]. Standing wave acoustic levitation can be done on continuous structures as well as several numbers of axes. Studies utilizing continuous structures have begun in 2010. Koyama et al. (2010) built a setup with a

rectangular plate as source and another rectangular plate as reflector [4]. The plate is excited at one of its bending modes and more levitation locations than a single axis setup is obtained among the plate. A circular plate used as a source in 2010 [5]. Both the source and the reflector were circular plates in that setup. The circular plate is excited at a bending mode and the excitation is given by piezoceramics. Annular plates are yet to be utilized in levitation setup. In this study, an annular acoustic levitation setup is designed. This setup includes an annular plate, an annular concave reflector, two Langevin Type transducers and waveguides, a signal generator, an amplifier and other supporting structures. Small polystyrene particles are levitated in the pressure nodes.

## 2. Standing Wave Acoustic Levitation

Standing wave acoustic levitation is performed by obtaining a standing wave between a source and a reflector. The source may be a continuous structure as well as a single source operating on a single axis. The source is radiating sound at a certain frequency. If the distance of the reflector to the plate satisfies the following equation

$$d = n \lambda / 2 \quad (1)$$

where  $d$  is the distance between the source and the reflector,  $\lambda$  is the wavelength of sound in air at the certain frequency and  $n$  is an integer, a standing wave is obtained between the source and the reflector. The pressure, particle velocity and force distributions are shown in Figure 1.

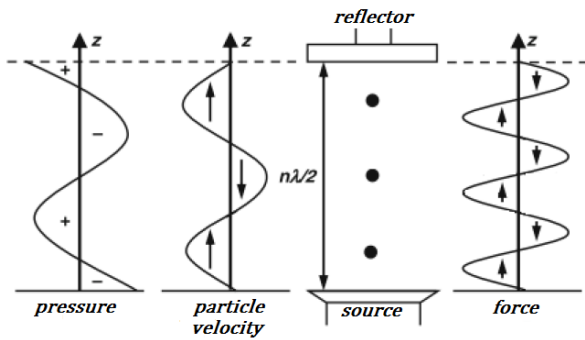

Figure 1 – Pressure, velocity and force distributions in a standing wave

### 3. The Setup

#### 1.1. Annular Plate

The annular plate is excited at one of its bending modes. Several types of the bending modes are evaluated and compared by the pressure distributions they generated with a flat reflector. As the transducers have an operating range of  $20 \pm 0.5 \text{ kHz}$  the bending modes are searched in that range for different combinations of dimensions. The simulations are done in COMSOL Multiphysics®. Of different types of bending modes, the selected is shown in the next figure.

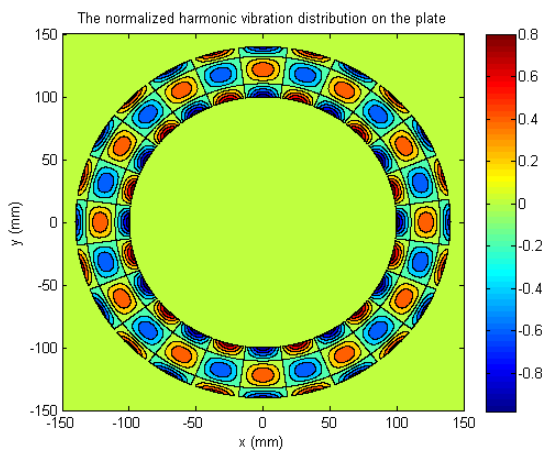

Figure 2 – The harmonic vibration distribution on the plate

When assembled with the waveguide, the plate will have the selected bending mode at 20400 Hz. The properties of the plate are given in the next table.

Table 1 – The properties of the annular plate

Property	Value
Material	Al5754
Inside diameter	200 mm
Outside diameter	280 mm
Thickness	3 mm

#### 1.2. The Waveguides and Transducers

The waveguides are of stepped horn type, with a flange at the step. Waveguides are fixed from their flanges, and the transducers are connected them from their bottom. When excited at the designed axial mode, the waveguide includes a half wavelength; the node is at the step, therefore at the flange. The transducers are of bolt clamped Langevin type and the model MPI-5050F-20L of the company MPI Interconsulting. The waveguides are connected to the plate 180° apart, and due to the mode shape has even number of peaks they are operating at the same phase. The tips of the waveguides are connected to the plate via three M5 bolts each. The assembled view of the waveguides and the plate is given in the next figure.

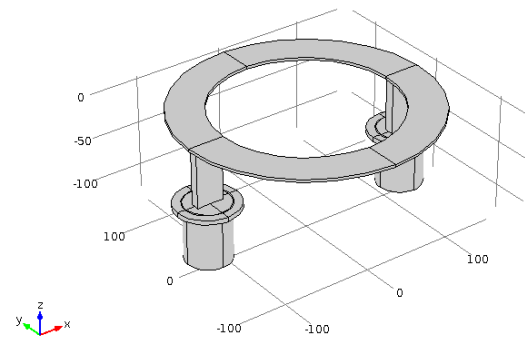

Figure 3 – The assembled view of waveguides and the plate in COMSOL Multiphysics®

The connection between the transducers and the waveguides are realized by M10 bolts. The waveguides are excited by sinusoidal signals generated by a signal generator (A Hp 25665A dynamic signal analyzer is used to generate sinusoidal signals.) and a Derritron TA300 power amplifier.

### 1.3. Reflector

A reflector is essential to obtain standing wave for acoustic levitation. The distance between the source and the reflector has to satisfy the equation (1). The number  $n$  in the respective equation also represents the number of nodes obtained between the source and the reflector. A flat reflector would be sufficient to obtain standing waves, but using concave reflectors higher acoustic pressures may be obtained. In this setup, an annular concave reflector with radius of concavity  $30\text{ mm}$  is used. The material of the reflector will be *ABS Plus* plastic, and the reflector is manufactured with uPrint 3d printer.

### 4. FEA of the setup

The finite element analysis of the levitation zone is done in COMSOL Multiphysics  $\text{\textcircled{R}}$ . The software allows simulation of acoustic levitation either acoustic-structure interaction mode or pressure acoustics mode. In the pressure acoustics mode the source can be represented as acceleration on one or more of the edges of the air. To represent the source, which is the annular plate here, the vibration distribution on the plate should be represented as a function of coordinates. The distribution on the radial direction is exported from the software and representing function is obtained by a least square curve fit operation which represents the distribution almost perfectly. The angular distribution can be simpler, there are 12 positive peaks among the plate hence a cosine function is enough. The distribution is obtained in the form.

$$W(r, \theta) = R(r)\Theta(\theta) \quad (2)$$

Where

$$R(r) = \text{Fitted polynomial} \quad (3)$$

$$\Theta(\theta) = \cos(12\theta) \quad (4)$$

As the vibration distribution is harmonic, the acceleration distribution will be similar to that of shown in Figure 2.

The assembled setup is also simulated and the vibration distribution is shown in figure 4.

The acoustic pressure distribution on a radial slice of the plate is obtained when the radius of concavity of the reflector is  $30\text{ mm}$  as shown in the figure 5.

The white lines in the region are the suitable locations for levitation. The location near the plate is close to the plate, thus an upside down

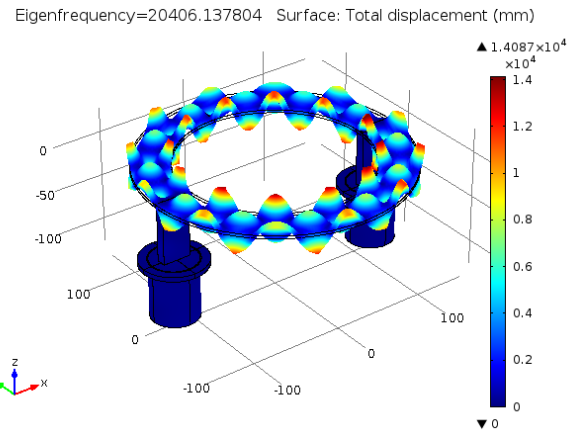

Figure 4 – Mode shape of the assembled setup

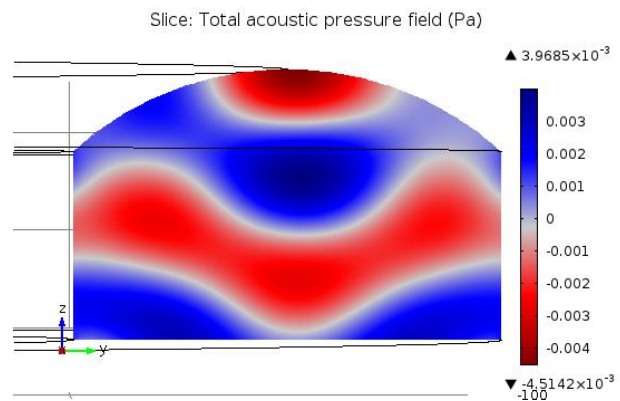

Figure 5 – Pressure distribution on a slice

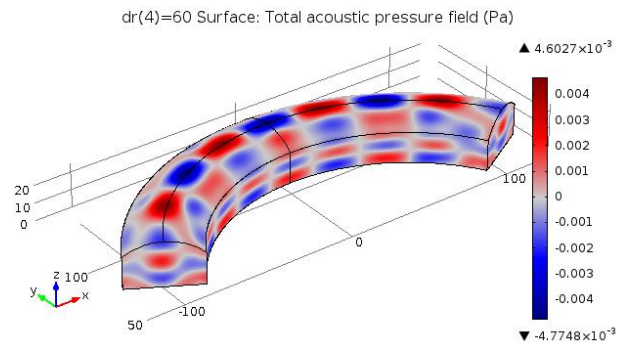

Figure 6 – Pressure distribution on the outer surfaces

arrangement of the setup would be better considering the gravity will pull the particles a little lower.

The pressure distribution on the surfaces of modeled air is shown in the next figure. Only a portion of air is simulated.

In the finite element analysis a normalized acceleration profile is used. The acceleration profile is obtained and it is divided by the maximum value in it. At the end, the maximum value of acceleration at any point is unity.

## 5. Experiments

Polystyrene particles of several mm of diameter are successfully levitated in this setup. The schematic diagram of the setup is below.

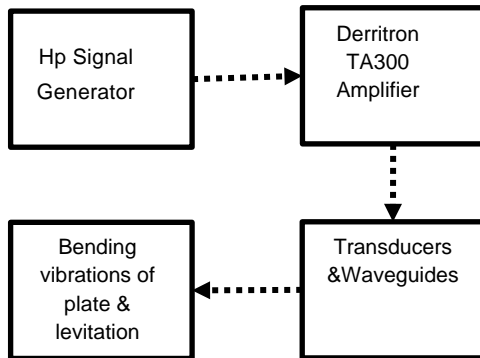

Figure 7 – Schematic diagram of the setup

The maximum voltage to be given to the transducers is  $20 V_{PP}$  due to the limits on the amplifier. The transducers are excited at the same phase. Assembled view of the setup is in the next figure. The reflector is placed upside down as the levitation locations will shift down due to gravity and doing so a better visualization is obtained. As the vibrations on the plate have angular symmetry around the central axis, a quarter portion of the reflector is manufactured and tested.

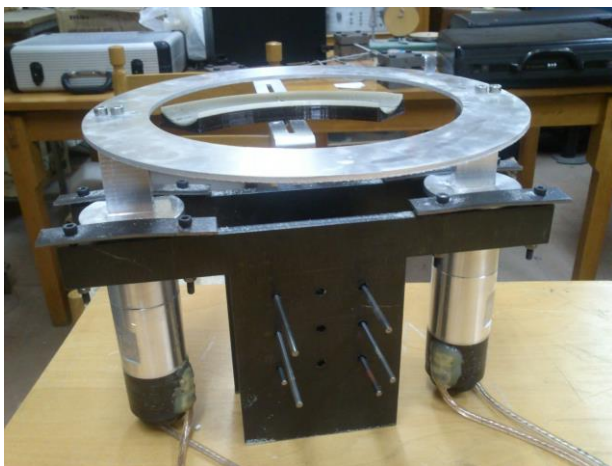

Figure 8 – Assembled view of the setup

The levitated view of the several millimeters of diameter of polystyrene particles is given. The particles trapped in the pressure nodes among the one eighth of the plate can be seen in the following figure. Although the presence of the bolts and the open end of the reflector disturbs the sound field a bit, all nine nodes of the nodes there are used for levitation.

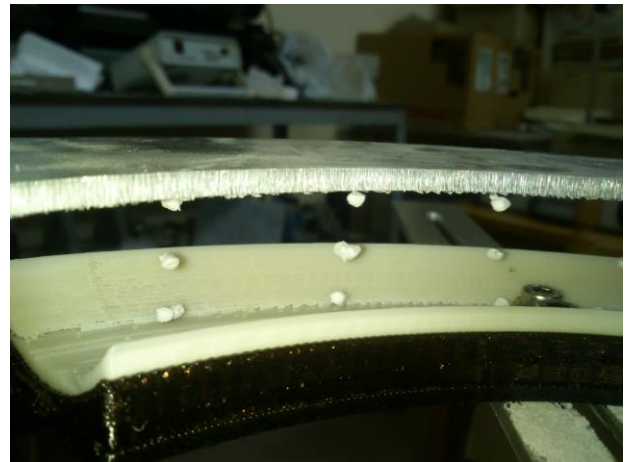

Figure 9 – Levitated view of polystyrene particles

## 6. Conclusions

In this study an annular acoustic levitation setup is built. Polystyrene particles of several mm's of diameters are successfully levitated. As the amplifier can only deliver  $20 V_{PP}$  at maximum, it was not possible to levitate heavier material such as water droplets. The orientation of the setup is upside down, i.e. the source is at the top and the reflector is at the bottom. Excitation to the plate is given by two Langevin type transducers and stepped horn type waveguides. The plate is excited at one of its bending modes and there exist 24 possible levitation axes among the plate. With this configuration 72 possible levitation locations are obtained in the volume between source and the reflector. In this setup a quarter of the setup is tested and levitation is succeeded at the corresponding nodes. Sound pressure is amplified and concentrated by using a concave reflector. The reflector is manufactured from ABS Plus plastic and it served good.

## Acknowledgements

This project has been funded by Middle East Technical University.

## References

- [1] Kundt, A. (1866). Ueber eine neue Art akustischer Staubfiguren und über die Anwendung derselben zur Bestimmung der Schallgeschwindigkeit in festen Körpern und Gasen. *Annalen Der Physik Un Chemie*, (4).
- [2] Whymark, R. . R. (1975). Acoustic field positioning for containerless processing. *Ultrasonics*, (November), 251–261.

- [3] Zhuyou, C., Zhimin, L., & Shuqin, L. (1992). Development of an acoustic levitation reactor. *Powder Tehcnology*, 69, 125–131.
- [4] Koyama, D., & Nakamura, K. (2010). Noncontact ultrasonic transportation of small objects over long distances in air using a bending vibrator and a reflector. *IEEE Transactions on Ultrasonics, Ferroelectrics, and Frequency Control*, 57(5), 1152–9.
- [5] Koyama, D., & Nakamura, K. (2010). Noncontact ultrasonic transportation of small objects in a circular trajectory in air by flexural vibrations of a circular disc. *IEEE Transactions on Ultrasonics, Ferroelectrics, and Frequency Control*, 57(6), 1434–42.